



NAIK RUBBER PRODUCTS



C/2, ANANDI INDUSTRIAL ESTATE, B.P. CROSS ROAD BHAYANDER
(E), DIST: THANE, PIN-401105

Industries we serve

We supply finish rubber products to almost every sector, the main 2 are Automobile & industrial sector.

In addition we supply products to some other sectors like:

.Bus body

.Railway

.Window section

.Power plant

.Valve & pumps

.Oven manufacture (Industrial/Bakery)

- .Pipe clamp fitting manufacture**
- .Control panel manufacture**
- .Switchgears manufacture**
- .Corrugated carton box manufacture**
- .Sugar factory machinery**
- .Lighting & fitting**

In addition to this we can develop any product

For any industry,

Whether it's molding, extrusion or sheet

1) BUS BODY PARTS



This is a J-Type EPDM RUBBER seal

Applied in window of buses &

Container at door as seal.

This is a T-type EPDM RUBBER seal

We make it for a bus body part supplier.



2) RAILWAY



This is a U-type EPDM RUBBER beading

We supply it to an Tier1 company they assembly this beading with metal parts and supply it to Indian Railways.



**These are two EPDM
RUBBER profile**

**This profile is fitted on
doors of A/C coach**



**The above profile is
extruded in the length of
2.5mtr**

**And it contains the
specific gravity of 1.2**

3) WINDOW SECTION

These are some picture of glass beading rubber profile, with picture of actual application.

All of this rubber profile are made from EPDM because the main property require in such application are Ozone & Weather resistance.



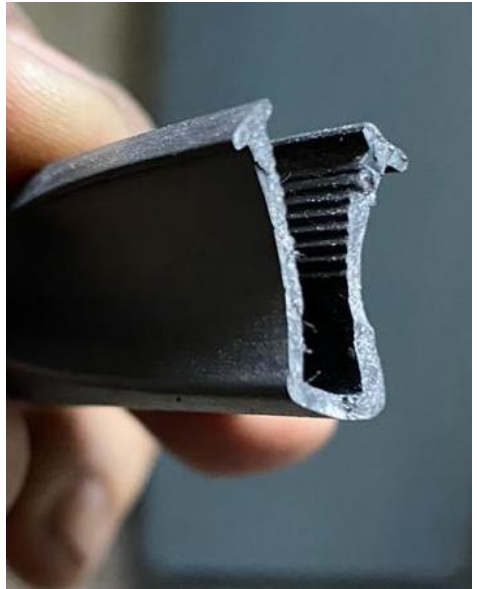



This kind of rubber profile is called as Grill rubber or U-type again it's made of EPDM.

Basically is applied in grill for gripping purpose.





**This is known as
GLAZING RUBBER. It's
made out EPDM**

**In this kind of profile
from one side the metal
is inserted and from
other side glass is
inserted.**

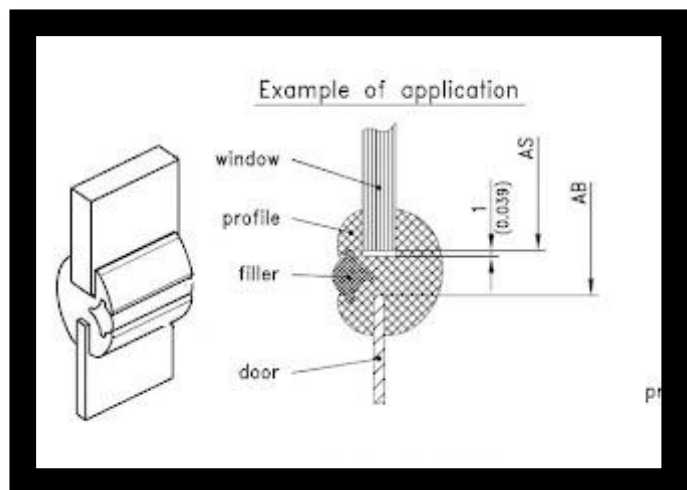

4) POWER PLANT



**This is an seal boot made up of
VITON (FKM)**

**This product can bear the
temperature of 280 deg C**



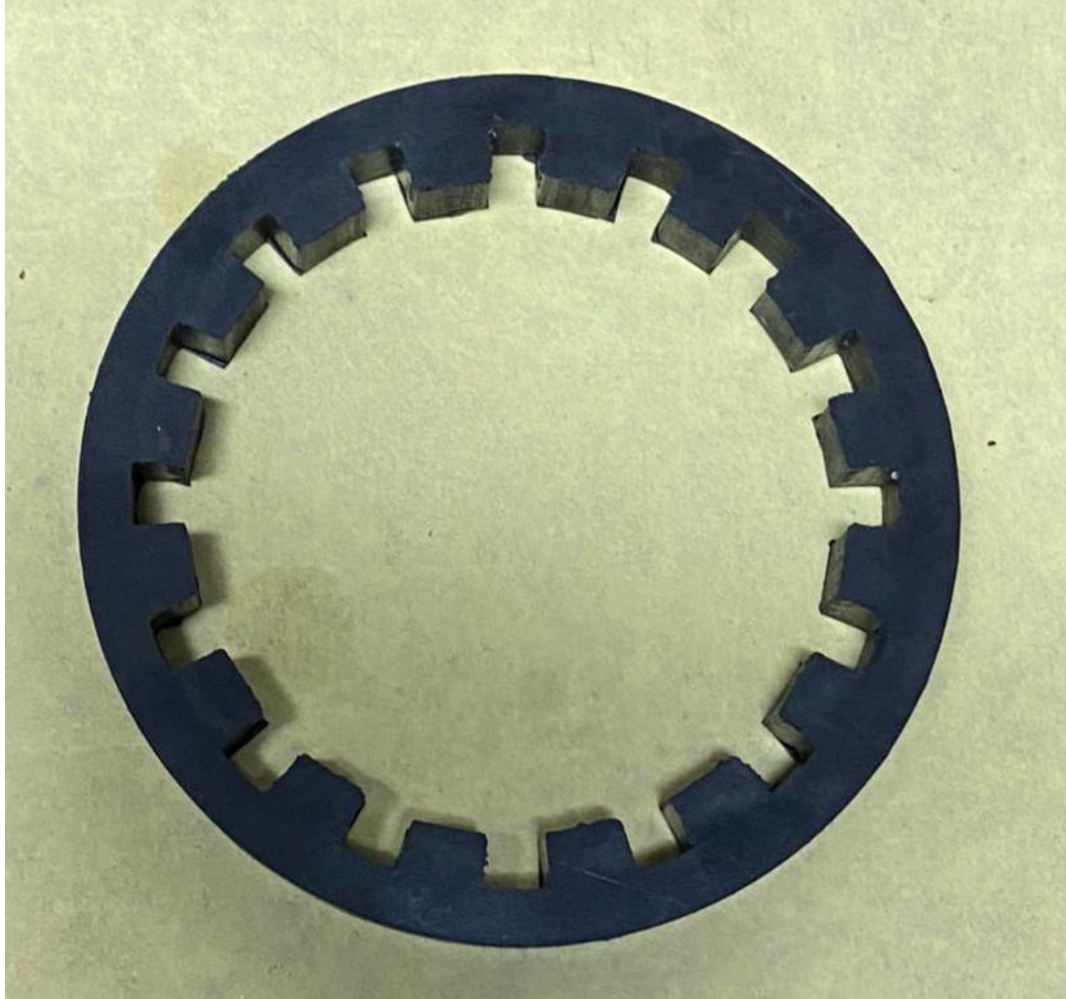

This rubber part is named as GEAR COVER

Made of NBR (NITRILE),

**We developed this part for one of our power
plant client**

Since he required an oil resistance rubber.

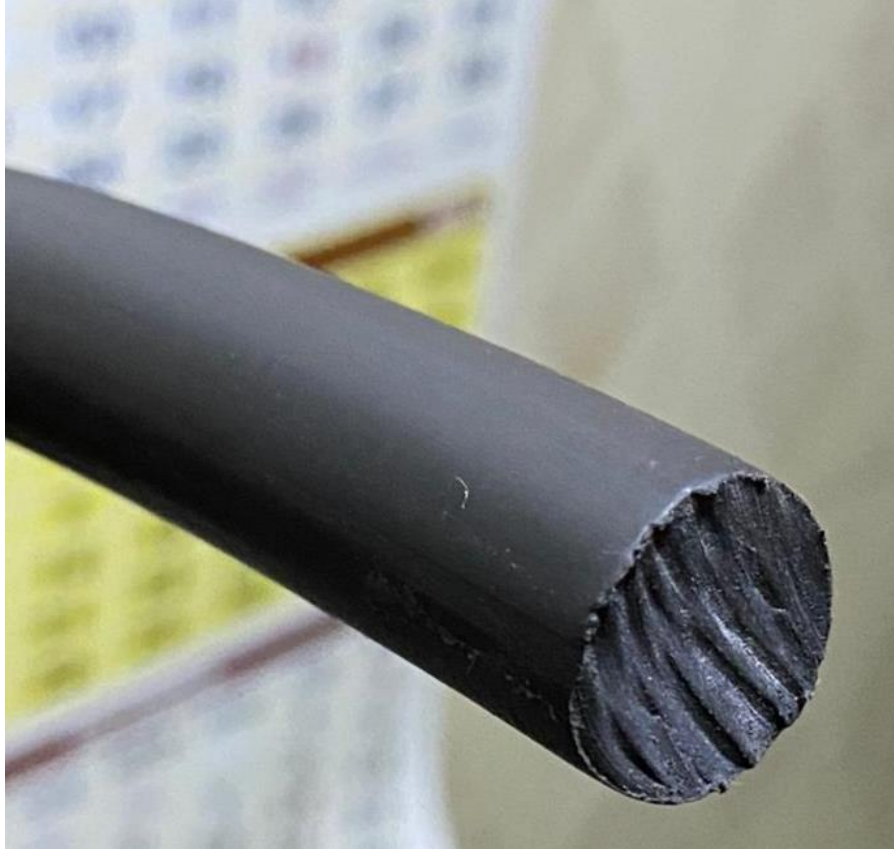

VITON RUBBER CORD



NBR RUBBER OVAL CORD

5) VALVE & PUMPS



We developed this product from PU to SILICONE for a client

Since PU was not meeting to his requirement

This product has hardness of 85 deg Shore 'A'



EPDM RUBBER O-Ring



**NATURAL RUBBER
Gasket**
**Applied between the
motor & pipe as
packaging**



We named it as a V-Type & M-Type seal

It's in an extruded form

Use as a sealing purpose for valve fitting

EPDM RUBBER tube

**With Specific gravity of
1.3**



6) OVEN MANUFACTURE (Industrial/Bakery)



**This kind of seal is fixed
at the doors of Ovens.**

**Both the material is
EPDM.**

**But the GREY one is
FOOD GRADE.**



This is also a Door deal for Oven Manufacture but the profile the different.

Also the material is VITON (FKM).

This kind of profile is called as E-Type.

This material is EPDM, it is also produced in silicone rubber.



Some manufacture uses this kind of profile as Oven door seal.

This material is EPDM Sponge.

With Specific gravity of 1.2.

7) PIPE CLAMP FITTING MANUFACTURE



This profile is called as C-Type CLAMP STRIP.

Material use in it is EPDM.

As you can see the application, use to lift metal rod.



8) CONTROL PANNEL MANUFACTURE



This is an EPDM RUBBER PAD applied in electrical panel.

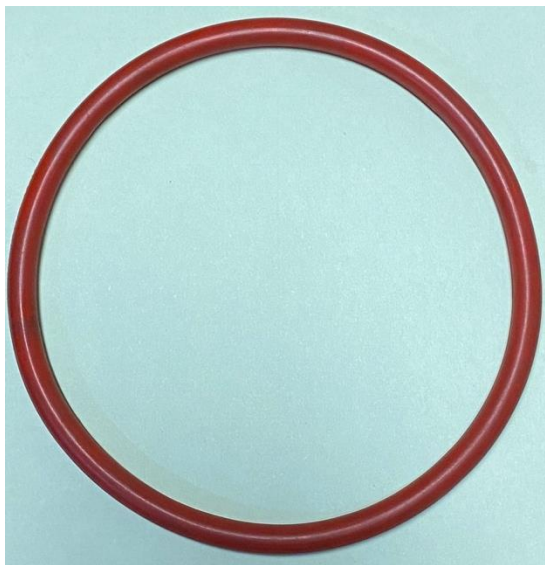

We make SILICONE RUBBER Strip & O ring, to an electric panel board manufacture.

For Insulation purpose.



**This 2 CR (NEOPRENE)
RUBBER GROMMET.**

**This is also supplied by us
to some panel
manufacture.**



9) SWITCHGEAR MANUFACTURE

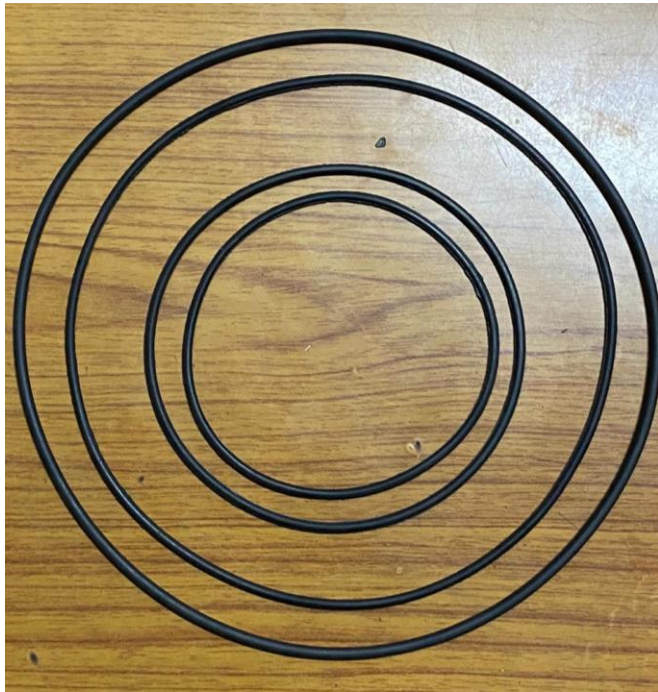

**This are 4 O ring
developed for our
Switchgear manufacture
client.**

**The material is CR
(NEOPRENE).**

**Since he required
flameproof O ring.**



10) CORRUGATED CARTON BOX MANUFACTURE



**This product is called as
NATURAL RUBBER
SPONGE SHEET.**

**Most use by the carton
box manufacture.**

**This is the product for
which NAIK RUBBER
PRODUCTS is known,
Only we in Maharashtra
are the manufacture of
such sheet.**

11) SUGAR FACTORY MACHINERY

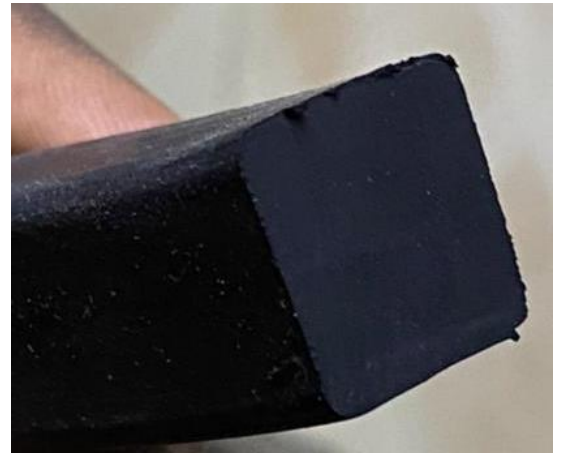

**These are some EPDM
RUBBER Profile**

**Use by Sugar Plant Industries,
as packaging & sealing.**



12) LIGHTING & FITTING

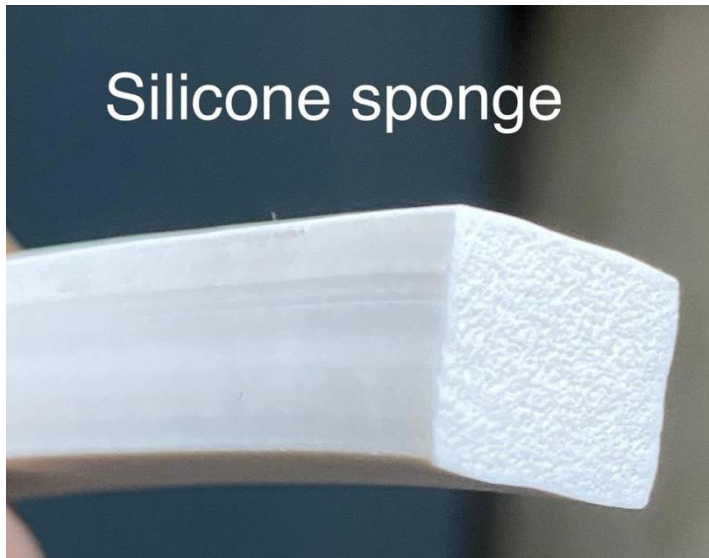

This SILICONE SPONGE profile is supplied by us to street light manufacture.



This EPDM profile is applied to step lights in theaters.

13) AUTOMOBILE PARTS



These are some of the
automobile parts
manufactured in NAIK
RUBBER PRODUCTS







14) Vender ship from Tier1 OEM supplier





15) We have developed some custom part for:

.Container ship



This material is EPDM

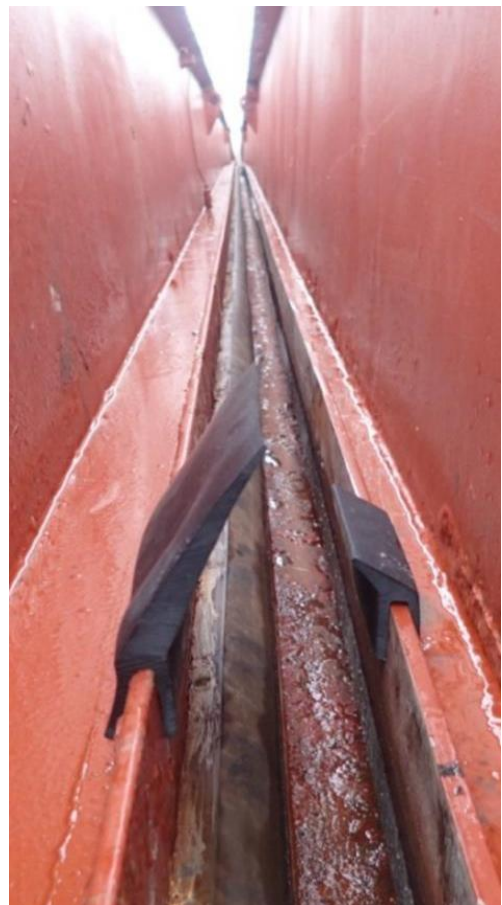

.Silicone Case for ONEPLUS BUDS Z



.HELMET BEADING



**This is an EPDM RUBBER
Helmet beading.**

**We developed this
custom profile for an
Helmet Manufacture.**

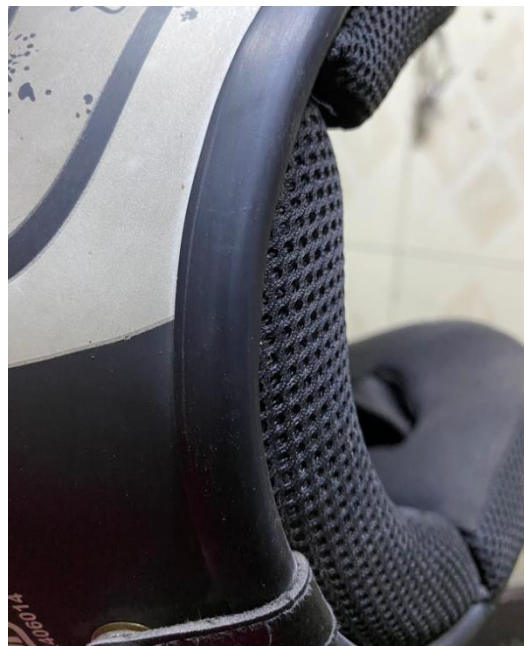

.PAINT BRUSH MANUFACTURE



This is an EPDM RUBBER STRIP,

Size of 10x5

We make this product for an Paint Brush manufacture

**Thank you for your
attention.**